



Ministry for the
Environment
Manatū Mō Te Taiao

Passive Solar Design Guidance

Disclaimer

This publication was produced by eCubed Building Workshop Ltd under contract to the Ministry for the Environment. While every effort has been made to ensure the material is as clear and accurate as possible, the Ministry for the Environment and eCubed Building Workshop Ltd will not be responsible for any consequences arising out of its use. This publication is general in nature and should not be taken as providing a definitive statement for any particular user's circumstances. All users of this publication should satisfy themselves and their client(s) concerning the application of this material to their situation and, where appropriate, seek expert advice.

Published in December 2008 by the
Ministry for the Environment
Manatū Mō Te Taiao
PO Box 10 362, Wellington, New Zealand

ISBN: 978-0-478-33139-4 (electronic)

Publication number: ME 913

This document is available on the Ministry for the Environment's website:
www.mfe.govt.nz



Ministry for the
Environment
Manatū Mō Te Taiao

Contents

Executive Summary	v
1 Passive Solar Design Checklist	1
2 Introduction	2
2.1 Background	2
2.2 Scope	4
3 Guidance on Passive Solar Design	5
3.1 Site, climate and building design	5
3.1.1 Design considerations	5
3.1.2 Site, climate and building design checklist	9
3.2 Daylighting	9
3.2.1 Design strategies	10
3.2.2 Daylighting checklist	13
3.3 Shading	13
3.3.1 Design strategies	14
3.3.2 Shading checklist	17
3.4 Thermal mass and insulation	18
3.4.1 Design strategies	19
3.4.2 Thermal mass and insulation checklist	21
3.5 Natural ventilation	22
3.5.1 Design strategies	23
3.5.2 Natural ventilation checklist	26
3.6 Computer simulation tools	26
3.6.1 Building simulation checklist	28
4 The Benefits	29
5 The Costs	30
6 Case Studies	31
6.1 Mathematics, Statistics and Computer Science Building	31
6.1.1 Site	32
6.1.2 Natural ventilation	32
6.1.3 Passive heating and cooling	32
6.1.4 Daylighting	33
6.1.5 Economics	34
6.1.6 Credits	34

6.2	Waitakere Hospital	35
6.2.1	Site	35
6.2.3	Natural ventilation	36
6.2.3	Passive heating and cooling	36
6.2.4	Daylighting	37
6.2.5	Economics	37
6.2.6	Credits	37
7	References	38
8	Further Reading	39
8.1	Passive design of houses	39
8.2	Integrated whole building design	39
8.3	Commissioning	39
8.4	Value cases	39
8.5	Sustainable building cases	39
8.6	Outline building briefs	39
8.7	Fit-outs	40

Figures

Figure 1:	Rough energy breakdown for a commercial office building	3
Figure 2:	An example manual shading study using the solar diagram from the CBPR	6
Figure 3:	Wind rose for Wellington	7
Figure 4:	Building footprints for best daylight access	10
Figure 5:	Daylighting guidelines for room dimensions	11
Figure 6:	The use of a sloped ceiling to improve daylight penetration into a room	12
Figure 7:	Overhangs (left) and sidefins (centre)	15
Figure 8:	Horizontal and vertical louvres	15
Figure 9:	A greenscreen (left) with the two meshes hung on the solid façade	16
Figure 10:	Shading strategies within a double skin facade; automated blinds are hung between the two glazing skins	17
Figure 11:	A trombe wall	19
Figure 12:	The internal structure of transparent insulation	20
Figure 13:	A thermal labyrinth (left) and a rockbin (right)	21
Figure 14:	Ventilation guidelines for room dimensions	23
Figure 15:	A typical natural ventilation strategy with an internal atrium	24
Figure 16:	Typical natural ventilation strategies within a double-skin facade	25

Executive Summary

This guidance document has been prepared for the Ministry for the Environment to assist the Govt³ programme's members. It provides guidance on how to incorporate passive solar design principles into future government building projects. Govt³ organisations will see significant reductions in energy use and improvements in internal environmental quality by using good passive solar design principles.

This document is one of a suite of guidance documents published by the Ministry for the Environment. Readers should also read the guidance relating to integrated whole building design and best practice building commissioning, available from the Ministry's website (<http://www.mfe.govt.nz/publications/sus-dev/>). Using all three guidance documents will help Govt³ organisations achieve and maintain buildings with good environmental performance over their lease term or life.

Buildings designed with passive solar principles have reduced operating costs, improved internal environments and higher user satisfaction. Increased user satisfaction leads to decreased absenteeism, fewer sick days and reduced staff turnover, which reduces payback times on any capital premium further.

Upfront capital cost premiums vary from project to project depending on the particular strategies employed. Passive design strategies should not add to these costs compared to a similar high-grade construction project using conventional strategies. Some features used to maximise the effectiveness of passive design do carry a cost premium, while others can reduce upfront costs.

This guidance document includes descriptions of passive strategies such as daylighting, shading, thermal mass, glass, insulation, and natural ventilation. There is also a brief discussion of the use of computer simulation. While each strategy is discussed separately, designers need to recognise the large degree of interaction between all aspects of passive solar design. For a building to perform successfully, the building's design needs to be considered as a whole, rather than as a collection of discrete, standalone features.

This guidance document also includes a summary checklist for design teams to follow when incorporating passive solar design into a building project. The design team should also refer to the body of the document for background to the underlying principles, design considerations and strategies at each stage.

1 Passive Solar Design Checklist

The checklist below provides an overview of the actions required to ensure the success of a building that uses passive solar design.

Activity	Complete		
	Small building ($\leq 500\text{m}^2$)	Medium building ($>500\text{m}^2$ $\leq 1000\text{m}^2$)	Large building ($>1000\text{m}^2$)
Committing as a design team to incorporating passive solar design principles through an integrated whole building design process.			
Carrying out a site investigation of solar gains, wind and other relevant parameters. If the site is yet to be determined, adding passive design factors into the site selection process.			
Determining suitable passive solar strategies and design options at the concept stage, including orientation and building form.			
Refining the design throughout the preliminary design phase using computer simulation. Investigating performance and selecting systems.	N/A		
Continuing the design development, taking note of the interaction between daylighting, heating, cooling and ventilation.			
Including a facilities management representative in the developed and detailed design processes.	N/A		
Completing the detailed design of passive systems including façade and glazing types, shading and ventilation strategy.			
Monitoring the construction process to ensure the integrity of sensitive passive design features.	N/A		
Carrying out building commissioning to Ministry for the Environment best practice guidance.			
Providing a building user guide, user training and facilities management training.	N/A		
Ensuring first-year building fine-tuning is carried out and providing feedback to the design team, including energy and water auditing.	N/A		
Continuous commissioning to be carried out every three years according to Ministry for the Environment best practice guidance, including post-occupancy evaluations and three-year building audits.	N/A		

2 Introduction

The Government is encouraging consumers to reduce energy consumption due to the likelihood of increasing energy prices, increased strain on the power network and the possibility of reduced security of energy supply. Government organisations signed up to the Govt³ programme must attempt to reduce their environmental impact over all areas of their operation, including energy use.

In June 2008, Cabinet directed public service departments to adopt, and specify in all contractual documentation, the use of passive solar design principles when designing new buildings from January 2009. This document offers passive solar design guidance to any user, though specifically targets Govt³ members to help them meet the Cabinet directive.

When first considering passive solar design, several questions are likely to arise:

- what is it?
- how does it work?
- what are the benefits?

The aim of this document is to guide you along the path of passive solar design and help you make better design decisions for long-term performance of your building. It aims to provide a single, simple and easy-to-understand source of information covering the basic principles, and detailed design strategies that can be used to achieve them. Some of the design techniques discussed in this report are:

- site, climate and building design
- daylighting
- shading
- thermal mass
- natural ventilation
- window systems
- computer simulation.

Also included in this guidance document are the costs and benefits of implementing passive solar design, a simple step-by-step checklist, and several case studies.

2.1 Background

Using heat and light from the sun to maintain thermal and visual comfort in a building is fundamental to sustainable development. This free energy offsets the energy requirements of artificial lighting and conditioning systems. Currently, around 19 per cent of New Zealand's electricity supply is used in commercial buildings (Ministry of Economic Development, 2006). The energy breakdown of commercial buildings varies widely across building types, though a rough rule of thumb is that the energy use can be broken down into thirds: one third for artificial lighting, one for heating, ventilation and air-conditioning (HVAC), and the remainder for tenant equipment such as computers, servers, copiers, and other small power loads (EECA, 2000).

Figure 1: Rough energy breakdown for a commercial office building

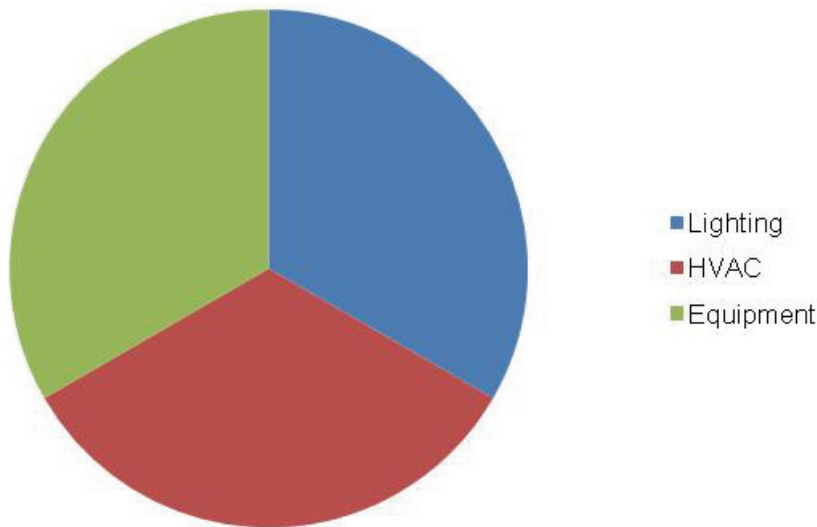

Note: Energy consumption is broadly split into thirds; one third each for lighting, HVAC and small power.

Using passive solar design principles can reduce, or possibly eliminate, a building's requirement for artificial lighting or mechanical HVAC. As a result, this can significantly reduce the energy consumption for lighting and conditioning a building.

Buildings that use passive solar design and have a greater consideration of internal environmental performance tend to achieve higher comfort ratings during post-occupancy reviews. While a building without a mechanical HVAC system usually experiences a higher variation in internal temperature and humidity, the occupants have a higher forgiveness for conditions in a passive building that otherwise would be unacceptable in a fully-conditioned building. This leads to a greater acceptance of the building and satisfaction with its performance as a workplace environment.

Various studies have associated passive design strategies such as natural ventilation (high fresh air volumes), daylighting and increased comfort with increases in staff productivity (Commission for Architecture and the Built Environment, 2005, Allen et al, 2004 and Haynes et al, 2000). In post-occupancy reviews, sustainable buildings are typically rated more highly by their users than their air-conditioned counterparts (Leaman, 2001). Because salary costs, for even a small organisation, far outweigh other operational expenditures, a small increase in productivity can pay back a cost premium for sustainable design in a very short time. Because sustainable buildings are typically healthier, staff turnover and absenteeism are reduced in buildings using passive solar design (Allen et al, 2004 and Haynes et al, 2000).

The Property Council of Australia (2003) also highlighted several important benefits of passive solar and sustainable buildings. These were:

- lower operating costs for energy, water and waste
- higher levels of occupancy satisfaction, health and productivity
- investors identifying with corporate environmental responsibility
- marketing advantages due to the point of difference
- a faster lease-up period
- marginal increases in rental

- higher tenant retention rates due to enhanced user satisfaction, health, comfort and productivity
- higher loan value and lower equity requirements
- higher building value on sale and appraisal
- asset protection
- overall greater return on investment.

Good passive design solutions rely on a complex interaction between several aspects of building design and building performance. While the following guidance contains different sections for different aspects of passive solar design, remember there will always be interdependencies across all areas of a building's operational performance that need to be fully integrated for the final design to be successful. Design teams should use an integrated whole building design process, which helps identify these interdependencies and allows the design team to work out solutions for all criteria or potential opportunities and problems. You can download guidance on the integrated whole building design process from the Ministry for the Environment website (<http://www.mfe.govt.nz/publications/sus-dev/>).

2.2 Scope

This guidance document relates to passive solar design of commercial or institutional buildings only and was developed with these buildings in mind. Please see the further reading section for information about applying passive solar design to other building types.

The discussion in this document covers only passive systems; active design features such as solar hot water, photovoltaic panels or mechanical assisted ventilation have not been covered. For information on active solar systems, visit the websites of the Energy Efficiency and Conservation Authority (<http://www.eeca.govt.nz>) and Solar Industries Association (<http://www.solarindustries.org.nz>).

3 Guidance on Passive Solar Design

This guidance document contains background information on design principles and strategies, and includes checklists for design teams to follow to help with the design process. The guidance covers passive solar design principles and their application to government buildings.

3.1 Site, climate and building design

How well passive solar design strategies might improve the performance of a building depends entirely on the natural resources and restrictions of the building's environment. As the phrase implies, 'passive buildings' must have a closer relationship with their surroundings (much more so than a conventional building) to achieve a comfortable internal environment with a minimum of resource use.

Before the design of the building can go ahead, a site investigation should be carried out. If a particular site receives little or no sun, there is little or no capacity for passive solar heating and the design must find other solutions for conditioning the building. Similarly, a site's wind resource will affect the natural ventilation strategy. A building's form, orientation and set out all need to be designed to make the most of the available resources.

3.1.1 Design considerations

As the local site and climate can determine the success or failure of a passive solar building, there are several fundamental considerations. These are as follows.

Overshadowing

The degree of solar access must always be determined before the design team can select appropriate passive design strategies. Topography or surrounding buildings may overshadow a site. Longitude will also determine the solar angles over the course of the year. The solar access of the site can be investigated using either a computer model of the site and neighbourhood or by using a sunpath diagram (available online from the [Centre for Building Performance Research \(CBPR\)](http://www.victoria.ac.nz/cbpr/resources/nz-sun-chart.aspx)): <http://www.victoria.ac.nz/cbpr/resources/nz-sun-chart.aspx>).

Figure 2: An example manual shading study using the solar diagram from the CBPR

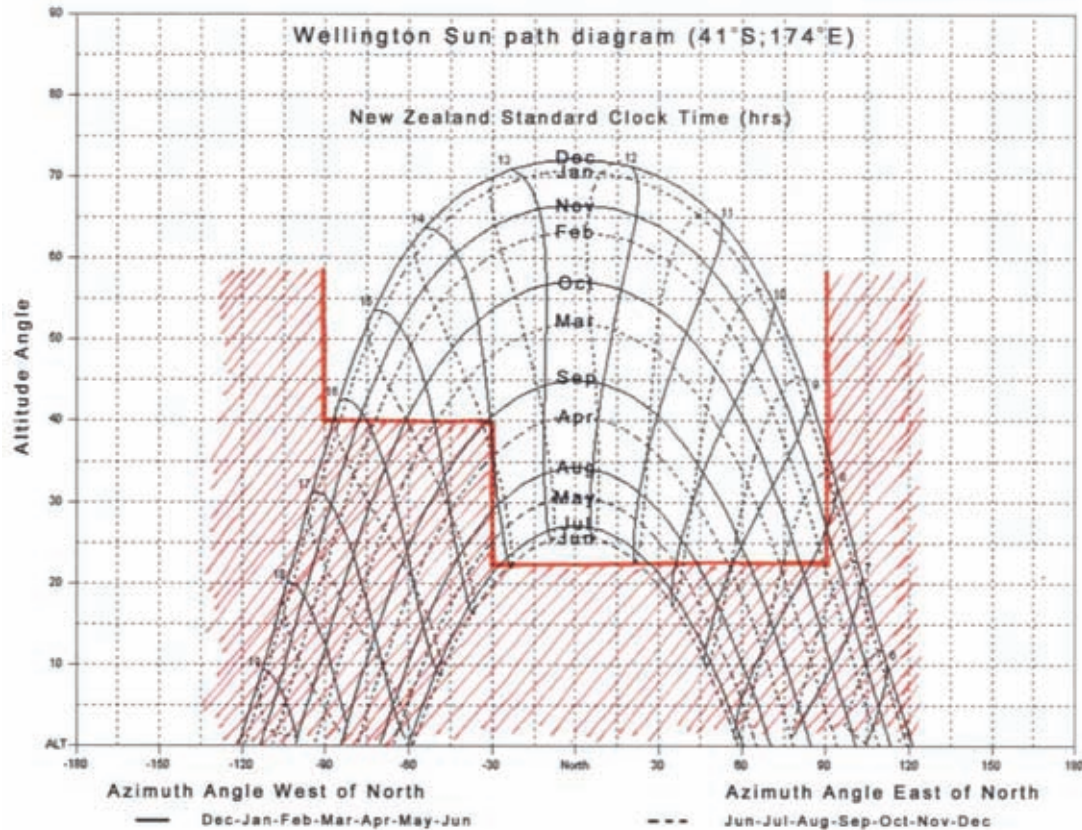

Note: The surrounding buildings are plotted according to their heights and locations. Their shading effect is manually blocked out leaving the proportion of the year for which a site has a clear view of the sun.

Once an overshadowing analysis is complete, the information is used to orientate the building on the site. The optimal angle for building in the southern hemisphere is a direct northern exposure. However, this may not necessarily be possible or desirable. As a rule of thumb, a building facing 30 degrees either side of due north will receive about 90 per cent of the optimal winter solar heat gain (Department of Energy, 2000). During winter months, the building must maximise any solar gains to help heat the building, while in summer months sun angles are higher so solar gains may need to be controlled, and in some instances mitigated to prevent overheating.

Windflow

The natural ventilation strategy will depend on the amount of windflow at the site. Some sheltered sites may have to depend on temperature-driven ventilation as wind speeds may be too low. Other exposed sites may have wind speeds too high for simple windows that can be opened and may require an engineered solution. It is important to remember that wind and temperature vary widely within a city and some sites can have their own unique microclimate. It may be necessary to collect weather data from a particular site for a time to gain a complete understanding of the site's unique conditions.

A wind rose is a visual representation of the wind conditions at a site generated from historical data. It plots average speeds and prevailing direction. It is relatively easy to produce from historical data, or from some building simulation software. Information from the wind rose is then used to find the best orientation for the building to maximise wind-driven ventilation.

Figure 3: Wind rose for Wellington

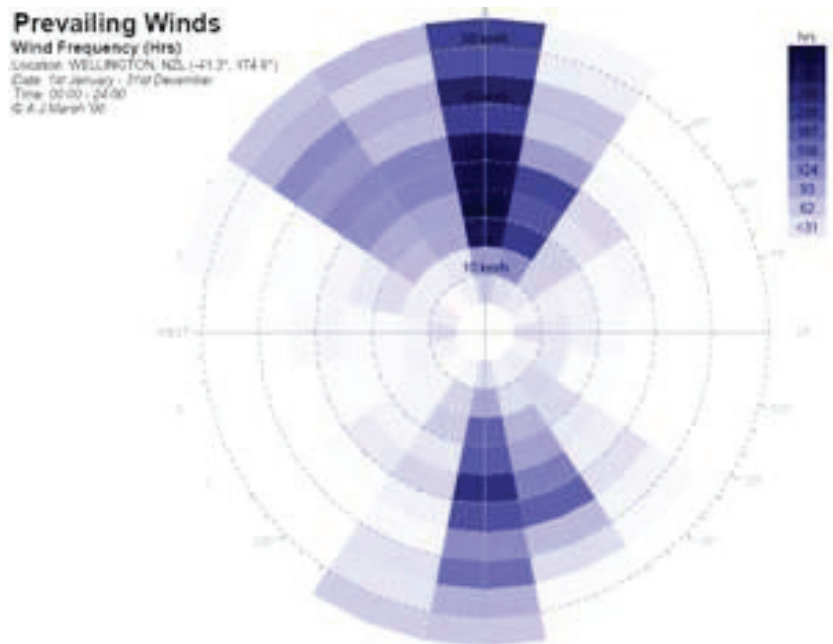

Source: Taken from Autodesk Ecotect

Note: The wind rose shows the direction of prevailing winds, their frequency and strength.

Temperature and humidity

It is important to design any building to suit the conditions it will experience throughout its life. In passive buildings, the building fabric and the external conditions combine to maintain a comfortable internal environment without reliance on mechanical systems. Temperature and humidity are two of the main determinants of human comfort. The external conditions need to be examined to estimate the level of performance required from the building fabric. It is often useful to plot climate data on a psychrometric chart (which shows the properties of air and the water contained in it at different temperatures). This gives the design team a visual reference as to the difference between external and desired internal conditions. Remember, too, that design temperatures for a location are based on hot and cold extremes rather than historical averages.

Planning restrictions

A site's limitations are not always physical. Local planning laws such as zoning rules, solar access planes and height restrictions, and national laws such as the New Zealand Building Code and the Resource Management Act, all apply restrictions to how a site can be built on. Preservation laws may also be an issue if retrofitting existing buildings.

Any existing infrastructure such as power lines, water and gas mains, sewers and drainage lines will have to be worked around. Traffic access requirements (both road and foot) may also influence the building's design, particularly parking requirements, which may have an effect on solar access, and building layout.

New Zealand currently has a performance-based building code, meaning that territorial authorities should still accept solutions which do not necessarily fit neatly into the code structure, but which can prove they meet the intent of the code. Passive solar design features often fall into this category. It may be necessary for a passive solar building to prove compliance with the New Zealand Building Code.

To avoid having Building Code compliance become an obstacle to the design aims of the building, the territorial authority should be consulted early in the design process. This will keep them informed about the design intent, and will allow them to accommodate design features that do not neatly fit the Building Code's acceptable solutions.

Layout and form

Consider the location of all habitable spaces, which are likely to have the greatest heating and lighting requirement. In most cases, these should be located towards the northern facade of the building to receive the most benefit from the sun. Spaces that are used least or are to be left unconditioned (eg, storage areas, toilets, lifts or garages) should be placed along the south wall where they can act as a buffer between high-use space and the colder south side of the building (Arizona Solar Centre). Areas of a building that are alike should also be grouped together so areas of similar gains and conditioning requirements can share common passive design strategies.

Building users

The most important factor in the ongoing environmental impact of a building is how the occupants use it. The building must meet the needs of the users or it will not be fit for purpose. Government buildings have the advantage that the client is already known and their needs (hours of operation, organisational structure, attitude to environmental issues) are reasonably well understood. These define the building's energy use and demands, and therefore the passive design approach. The organisational structure should also play a role in determining the building layout.

To ensure the building is used properly once built, the users need to have a good understanding of how the building works and how their actions affect the building's performance. The design team should involve future users and facilities management staff in the design process, and develop a building user's guide to inform occupants of the building's design intent. This means they are better able to maximise the performance of their building, and the utility they receive from it.

The commissioning of buildings is extremely important in making sure the building performs as intended and achieves the design performance targets. Again, the facilities management team should be involved in a full commissioning process, and ongoing tuning should continue for the first 12 months of operation. The Ministry for the Environment has published guidance on best practice commissioning of buildings which is available from the Ministry's website (<http://www.mfe.govt.nz/publications/sus-dev/>). Details have also been included in the Further Reading section of this guidance document.

3.1.2 Site, climate and building design checklist

- Carry out a study of solar access, overshadowing and wind flow at the site.
- Examine temperatures and determine the difference between external conditions and those desired inside the building.
- Liaise with your territorial authority to determine restrictions on the site. Inform them of your design intent and find solutions to any regulatory issues. Maintain this link throughout the design process.
- Finalise the building orientation and layout according to site conditions and organisational structure.
- Develop a user guide and carry out commissioning to best practice guidelines.

3.2 Daylighting

Daylight design is the use of light from the sun and sky to complement or replace artificial light (O'Connor et al, 1997). Daylight consists of three components:

- direct light from the sun
- diffuse sky components or daylight scattered in the atmosphere
- daylight reflected from surrounding surfaces, such as buildings and the ground.

Daylight is generally preferred above artificial lighting. It is free, has perfect colour rendering and a positive effect on human well-being (International Energy Agency, 2001). Research has linked good daylighting with worker productivity and comfort, and with some daylit workspaces having lower tenant and employee turnover rates (O'Connor et al, 1997).

Passive daylighting systems use windows and shading or redirecting devices to enhance the quality and performance of daylight in a space. Decisions made in the early design phase can determine the overall success of the system. Appropriate window products and lighting controls are used to optimise daylight performance and to reduce electric lighting needs, while meeting the occupant lighting quality and quantity requirements (O'Connor et al, 1997). Artificial lighting and its associated requirement for cooling energy, contributes an estimated 30 to 40 per cent of a commercial building's total energy use (O'Connor et al, 1997). For this reason, daylighting is the most cost-effective strategy for targeting these energy uses, as savings of 40 to 80 per cent are achievable through effective daylighting design in perimeter zones of office buildings (Levine et al, 2007).

Two major sources of heat gains in commercial buildings are artificial lighting and sunlight. The heat gains from artificial lighting can be reduced when a predominantly daylighting system is used (International Energy Agency, 2001) and limiting direct sunlight transmitted into the space will prevent overheating (Levine et al, 2007). Therefore, daylighting strategies need be optimised to use as little artificial light as possible, but even the best daylit buildings will need some complementary or artificial lighting for after-hours use.

3.2.1 Design strategies

It is extremely important to consider daylighting strategies from an overall perspective. It is not just a question of illumination available on a horizontal surface, but the interactions between light quality, climate, building function, orientation, occupants, solar gains and building design (Hastings, 1994).

Building form

Selecting an appropriate building footprint can allow a building to maximise the use of the daylight available, where long narrow footprints are preferable to square ones (O'Connor et al, 1997). The following floor plans are some examples of layouts that distribute and use daylight effectively.

Figure 4: Building footprints for best daylight access

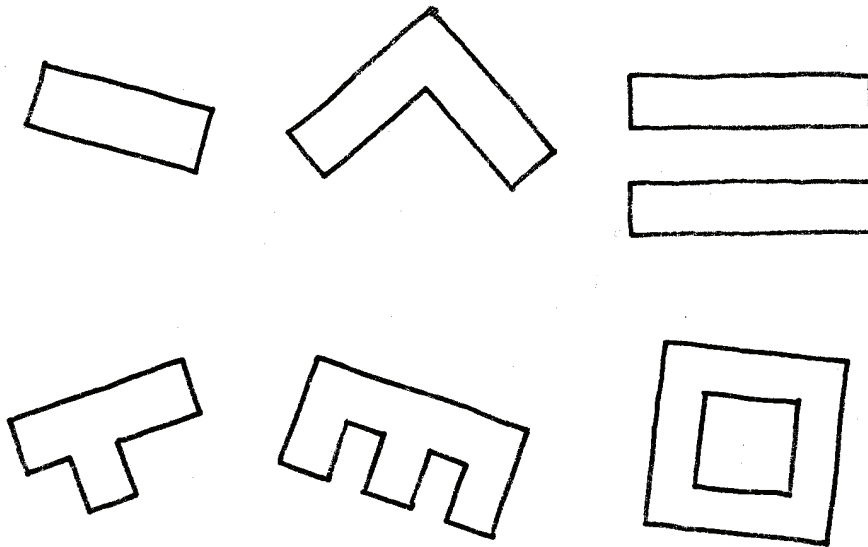

Note: The shape of the building makes use of long, narrow sections arranged to allow daylight into as much of the floor plate as possible.

These building forms are not always appropriate and can produce 'cookie cutter' buildings. In these situations, systems that allow daylight into the core of the building, such as clerestories, atria and light-wells are other options.

The following features should also be included where possible (O'Connor et al, 1997):

- north/south exposures, as they are generally preferable to east/west (preferably within 30 degrees of the north/south axis). Remember that this rule of thumb refers to true north rather than magnetic north (around 20° east of north, though this varies throughout the country)
- windows on two sides of the space, to provide better daylight distribution
- room depths within one-and-a-half to two times window head height for adequate light levels and balanced distribution.

Figure 5: Daylighting guidelines for room dimensions

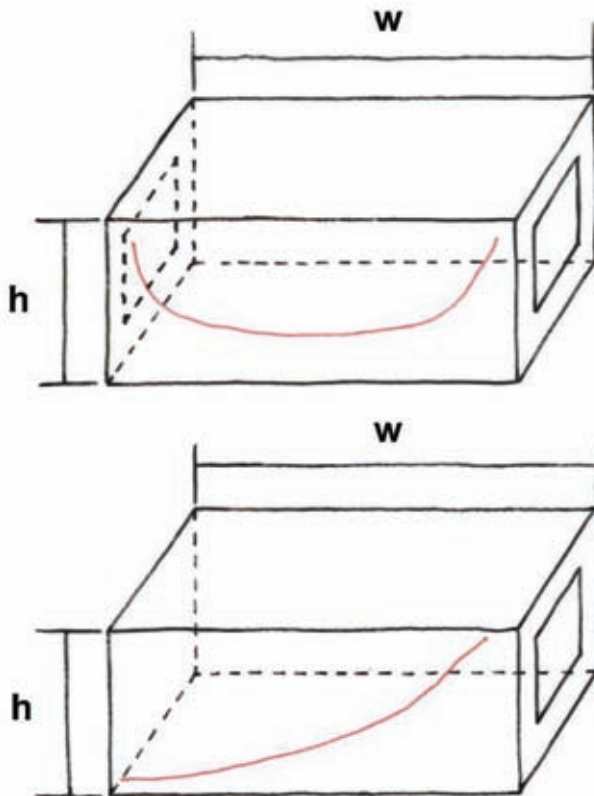

Note: For two-sided daylighting (top) the room width (w) can be between three to four times the ceiling height (h). In the case of one-sided daylighting (bottom), w can only be one-and-a-half to two times h .

Room features

When designing the room layout, spaces should be located relative to their tasks. Tasks requiring higher light levels and that are performed regularly should be located near windows, and tasks with little need for daylight that are performed infrequently should be located in non-perimeter or core areas (O'Connor et al, 1997).

Furniture layout should not block light to spaces further from the window. It is important that full-height partitions, bookshelves and files are not positioned parallel to window walls (O'Connor et al, 1997). If partitions are in use, clear or translucent materials in the upper portion of full-height partitions are needed (O'Connor et al, 1997).

When selecting materials, use surfaces with high reflectance as these will result in higher light levels at the rear of the space and the distribution of light is more even. Dark surfaces should only be used for emphasis and kept away from windows (O'Connor et al, 1997). The recommended surface reflectance is:

- ceilings: > 80 per cent
- walls: 50–70 per cent
- floors: 20–45 per cent.

Introducing a sloped ceiling is a simple way of improving daylight distribution at the rear of a space. Locating ducting at the back of the space will also allow high windows to fit within the standard floor-to-ceiling height (Hastings, 1994).

Figure 6: The use of a sloped ceiling to improve daylight penetration into a room

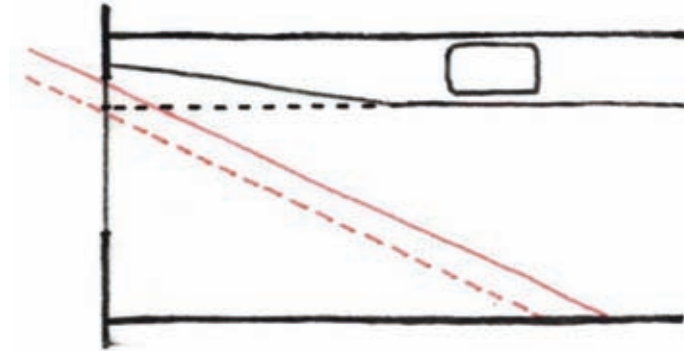

Note: The higher ceiling at the perimeter allows higher windows to be used. These can be integrated with other daylighting features such as lightshelves and clerestory windows. Service ducts need to be moved inwards from the perimeter of the building to allow for the reduction in ceiling void.

Windows systems

Windows on every orientation can provide useful daylight, but each orientation needs to be treated differently. North facades provide good access to strong illumination, but vary throughout the day and require shading. South facades provide high-quality, consistent daylight with minimal heat gains, but thermal loss occurs on cooler days. East and west facades also require shading, but have to take account of lower sun angles (O'Connor et al, 1997).

The practical depth of a daylit zone is typically limited to one-and-a-half times the window head height. With standard window and ceiling heights, adequate daylight extends to within 4.6 m from the window (O'Connor et al, 1997). Note that the higher the window, the deeper the daylight reaches into the room.

A good approach for excellent daylighting and glare control is separating view and light windows. Use high-transmission, clearer glazing in high level (or clerestory) windows, and lower-transmission glazing in view windows to control glare (O'Connor et al, 1997).

Diffuse glazing on the interior face and glass blocks redirect skylight to the deeper parts of the room, to a limited degree, from where the sky is not visible. The same type of prisms can also be used to redirect sunlight to the ceiling, giving shading in the front of the room, and generally increase daylight levels by diffuse reflection from the ceiling (Hastings, 1994).

Insulated glazing units can be used to reduce the heating losses normally associated with single-glazed windows and can still allow a good distribution of daylight (Hastings, 1994).

The following principles should be used when designing the daylighting system (O'Connor et al, 1997):

- large windows require more measures to control glare and heat gains
- strip windows should be used as they provide a uniform distribution of daylight
- locating windows near room surfaces will provide good distribution as these surfaces will help reflect and redistribute the daylight

- glazing area should not be wasted where it cannot be seen, such as below desk height, as it wastes energy, causes discomfort (especially in winter), and provides little benefit.

Daylight controls

At night, electric lighting must be able to provide all necessary lighting. In addition, during the day, whenever daylighting provides insufficient light levels for a particular task, electric lighting can be used as an additional source of light. Daylight controls are an invaluable tool that switch electric lights off (or dim them down) when not required. The controls are programmed with a desired setpoint and then adjust the electric lighting to top up the available daylight. As electric lighting contributes to a building's cooling load, using daylighting controls will also reduce the energy used for cooling the building, further reducing operating costs (International Energy Agency, 2001).

3.2.2 Daylighting checklist

- Use information from the site investigation to choose appropriate building orientation, form type, orientation and internal layout.
- Select window shape and position.
- Select appropriate shading devices and glazing types to control glare and solar gain.
- Consider the thermal implications of daylight design.
- Ensure the interior colour scheme is suitable for daylight design.
- Investigate integrated light control systems for energy efficiency.

3.3 Shading

In an attempt to incorporate daylighting into a building, designers often make the mistake of simply increasing the glazing area as much as possible. Unfortunately, good daylighting is not that simple. Large, unprotected areas of glazing can lead to discomfort to occupants through glare, and high solar gains can affect the building's energy use. It is important when designing a building that these effects are considered in the overall design strategy.

Glare is usually at its worst when the sun is low in the sky; in the early morning, late afternoon, and during the winter months. While glare from the sun is usually only a short-term phenomenon, the effects can be quite strong and can result in a marked reduction in staff productivity, for example, they may not be able to read a computer screen. As glare effects vary over time and location and even person to person, the ideal shading strategy should be relatively flexible and allow the building users to adjust the shade to suit the immediate situation. The best examples are adjustable louvre blinds that an individual can raise or lower and then tilt to block their glare source.

Solar gains are required to reduce heating loads during winter months, however, too much solar gain can result in uncomfortable internal temperatures or increased cooling energy if air-conditioning is installed. The shading design needs to find the balance between the two, normally through optimising the shading to eliminate summer sun, while allowing winter sun to pass into the building. To reduce heat gains, external shading devices are the best-performing option; internal shading slows heat down, reducing peak loads, but still allows the majority of the sun's heat into the space. Note that this contradicts the ideal case for glare mentioned above.

Design teams need to apply the information from the site shading study to the building envelope when considering effects from direct sun. It is important to remember that the northern facade will often receive the most solar gains during winter, when the low-angle sun penetrates deeper into the space. The eastern and western facades will also receive high heat gains, particularly the west, which can often become superheated by late afternoon sun after a full day of solar gains. Furthermore, during a New Zealand summer, the sun rises and sets approximately 30 degrees to the south of due east and west, and if a building has extended hours of operation the southern facade may need shading in some way. Sunpath diagrams are available from the Centre for Building Performance Research (<http://www.victoria.ac.nz/cbpr/resources/nz-sun-chart.aspx>).

3.3.1 Design strategies

Many of the shading design strategies were discussed in the related section on daylighting. A good shading solution should compliment the daylighting design, along with any other strategies being incorporated into the building.

Fixed shading devices including overhangs, light-shelves and diffuse panels can be used to shade and redirect light into a space where it is useful. Using these shading systems will also reduce solar gains and glare. Several possible design options are discussed below.

Overhangs and sidefins

Permanent devices such as overhangs are common in hot climates and present the advantage of having little or no effect on views and, when placed above the top of a window, they allow low-angle winter sun and block high-angle summer radiation. The advantage of using permanent window protection is generally limited to windows facing north. For windows facing east or west, other devices must be used because of the lower sun angle. Vertical projections or sidefins offer a way to shade these windows (Hastings, 1994).

Figure 7: Overhangs (left) and sidefins (centre)



Note: Both need to be sized according to sun angle and orientation; overhangs for high summer sun, sidefins for low-angle sun in the morning and afternoon. The image on the right is of the Christchurch library showing deep overhangs to block direct sun for most of the year.

Fixed louvres

The design of the louvre arrangement needs to be optimised to eliminate undesirable sunlight. This affects the depth (often determined by the product used), spacing and orientation of the louvre blades. Horizontal louvres are best used on the northern facade, where the sun tends to be higher, while the western and eastern facades would benefit from vertical louvres, or a different strategy altogether, such as blinds or external mesh screens, as the sun is lower in the sky in the mornings and afternoons and sunlight will pass directly through horizontal louvres. Louvres can also be automated for maximum efficiency; however, as they are on the exterior, they can be difficult to maintain and obscure external views (Hastings, 1994). The considerations of maintenance and effects on external views should therefore be added to the decision-making process.

Figure 8: Horizontal and vertical louvres



Note: Horizontal louvres are best at blocking high daytime sun, while vertical louvres block low-angle sun and are best suited to east and especially western facades. The image shows louvre orientations changing around the facade of one building.

Light shelves

Light shelves block direct sun while reflecting daylight off the room's ceiling deep into the space. Light shelves are discussed further in the Daylighting section of this document.

Roller blinds and internal louvres

Fully adjustable shading options are the most effective at dealing with glare. They allow the occupants to adjust blinds or louvres to suit the glare source at the time. The disadvantages of movable devices are that they obscure the external view and release absorbed solar gains into the room. This can be diminished with reflective materials, but these materials can result in visual discomfort associated with glare. The upside is internal shading devices are often included as a fit-out item and can easily be retrofitted into a wide variety of existing buildings.

Screens

Mesh screens hung around the outside of the building are a very effective shading device and can be a striking aesthetic feature. They have the advantage of providing an even amount of shading over the entire building facade, rather than the 'all or nothing' effect of louvres. The evenness of the shading also means that occupants maintain reasonable connection with the external view, depending on the level of transparency of the mesh. Internationally 'green screens' have been used, which use a climbing plant between two metal grids, such as reinforcing mesh. Using plants on the side of a building gives an interesting aesthetic and helps reduce a building's visual impact on the environment. The degree of shading depends on the density of the planting. Green screens do have a relatively high maintenance requirement and require irrigation.

Figure 9: A greenscreen (left) with the two meshes hung on the solid façade



Note: The image on the right shows a mature greenscreen in use. Note that for shading purposes the greenscreen should extend over the windows.

Double skin facades

A double skin facade provides a sheltered space outside the occupied space where blinds or louvres can be set. This allows the occupants to benefit from the flexibility of movable shading while also preventing solar gains from re-radiating back into the occupied space. Blinds are automated and controlled by light sensors on the facade, which raise, lower and open or close the blinds to suit the conditions at any given time during the day. The building's management system (BMS) integrates the control of the blinds with the conditioning systems to ensure efficient running of the building. Ideally, there should always be a manual override to allow user control if required. For best results, a double skin facade should be on the northern facade of the building so that it receives as much heat from the sun as possible to drive the natural ventilation. Double skin facades can be expensive, as they are essentially doubling the glazing requirements for that face of the building, although they have the benefit of having other passive design strategies, such as light shelves or natural ventilation, fully integrated.

Figure 10: Shading strategies within a double skin facade; automated blinds are hung between the two glazing skins



Note: Lightshelves and clerestories can be used to allow daylight into the room (in this case with a sloped perimeter ceiling). Blinds and lightshelves can be integrated with the double skin facade's maintenance walkways, which can also act as a diffuse overhang.

3.3.2 Shading checklist

- Assess potential areas of concern for glare and overheating.
- Select appropriate shading solutions for each facade depending on orientation and site conditions.
- Incorporate shading with the intended daylighting strategy.
- Refine to the final solution taking account of heat gains, glare and glazing type.

3.4 Thermal mass and insulation

The combination of thermal mass, glazing type and design, and insulation form the three pillars of good passive design. Their interaction needs to be carefully considered to achieve the best result.

Thermal mass stores heat when there is an excess of passive solar energy and/or internal gains in a building, and releases the stored heat as the building starts to cool down. Mass also reduces the swings in peak temperature and, for this reason, thermal mass is often required in a passive solar building to bring the temperature variations within acceptable limits and/or to reduce the peak cooling loads.

Thermal insulation, on the other hand, slows the transfer of heat through walls, floors and ceilings, both inwards and outwards. This results in reduced energy costs and helps maintain a uniform temperature by retaining heat during the winter months and keep the building cool during the summer months.

Thermal insulation in buildings is an important factor in achieving thermal comfort for occupants and it helps reduce the energy demands of heating and cooling systems. The most important component of insulation is its R-value (or thermal resistance), where the greater the R-value the better it is at resisting heat movement.

Several types of insulation products exist including insulation batts and blankets, foam insulation, blown insulation, rigid insulation panels, and insulating materials incorporated into other products such as cladding and structural components. Ideally, insulation should be kept separate from the internal environment as some types of insulation collect dust and can add particulates to the air.

When conditioning a building through passive solar design, the design team needs to understand the likely internal gains within the space and their interaction with the desired internal conditions. A lot of passive design literature assumes a predominantly heated building and then makes recommendations on how to use thermal mass and insulation to reduce heating energy. Some building types will have a higher cooling requirement due to the high internal heat gains from people, office equipment and so on. In this case, thermal mass should be used to cool the building by storing heat from the occupied space during the day and releasing it when the room is unoccupied.

The relative positioning of the building's thermal mass and insulation are one of the keys to passive solar design (Hastings, 1994). In a low-gain building, mass should be located to receive solar gains from the sun, normally on the floor or as a trombe wall (a thermally massive wall in full view of direct sun). In a building with high internal gains, the mass should be placed away from the sun to prevent the space becoming superheated by the combined effect of mass and the internal gains. This is usually achieved by absorbing excess heat in exposed ceilings.

The building's facade design needs to be balanced with daylighting requirements. Visible light transmission needs to be balanced with solar gains, while also considering glare effects. Solar gains are the free heat from the sun central to passive design, although this can be undesirable in high heat-gain buildings. Glazing areas and glass selection need to be optimised for all facades, and may vary around the building depending on orientation.

3.4.1 Design strategies

There are many thermal mass systems commonly used, some of which are detailed below.

Mass storage systems

A mass storage system combines collection, storage and transport of solar energy in one unit and allows the building to work simultaneously as a solar collector and as a storage device. A trombe wall is particularly well suited for buildings that have significant heat load during the night, as the release of heat from mass during this time can help meet the night heating load, avoiding or minimising the need for auxiliary heating (Hastings, 1994).

Figure 11: A trombe wall

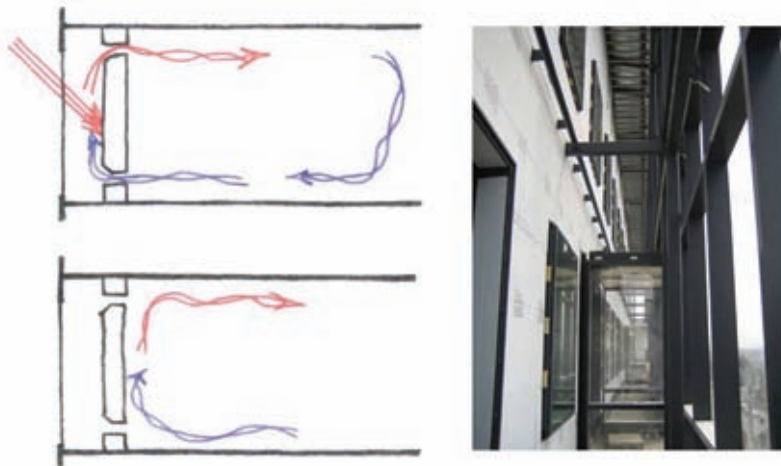

Note: During the day (top left) heat from the sun warms the mass of the trombe wall which circulates warm air into the space. Cooler air then convects round to the wall to receive more heat. During the night (bottom left) heat stored in the wall is released back into the room. The image on the right was taken in the cavity between the glazing line and the heavy trombe wall. Vision windows are still used for natural lighting and views.

Transparent insulation systems

The performance of the mass wall system can be greatly improved with transparent insulation as the glazing. Solar radiation is partially transmitted through the insulation to be absorbed at the exterior surface of the wall. Depending on solar radiation, the wall heats up and temporarily transfers heat from the outside to the inside. During periods of weak or no radiation, heat losses are minimised by the insulation level of the material layer on the outside of the wall. In periods of higher radiation, the external walls absorb radiation, store heat and can temporarily heat the surface of the adjoining space (Hastings, 1994).

Figure 12: The internal structure of transparent insulation

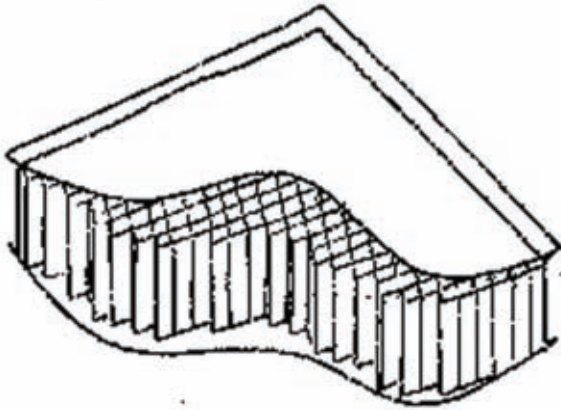

Note: The cellular internal structure retains heat while still providing diffuse daylight into the room.

Insulation

The role that insulation plays in the building is determined by its placement. When used in the building envelope, it is preventing heat flow from the inside to outside, either containing heat within the building or preventing it from entering. Insulation can be used to isolate thermal mass, shielding the massive elements from unwanted solar gains, or shielding occupied areas from the unwanted effects of thermal mass.

It is important to note that any building material has an insulating effect. This is most apparent with floor coverings on concrete slabs. Timber or carpet will effectively insulate the slab and reduce (or eliminate) its effectiveness as a heat sink. Internal strapping and lining to walls will have the same effect, as will acoustic ceiling tiles.

Night purge

In high heat-gain buildings, there may be residual heat at the end of the day which, if retained overnight, can lead to overheating the next day. To remove the residual heat, the building is ventilated overnight. The cool night air draws the heat out of the thermal mass or insulated envelope and releases it back outside. With a lower initial temperature at the start of the next day, the building is less likely to overheat, thereby improving comfort and reducing cooling requirements.

Thermal labyrinths and rockbins

Thermal mass can be used within the air delivery system to moderate the temperature of the supply air. These systems include complex designs like thermal labyrinths and rockbins, although they can also have simple solutions such as running air supply ‘ducts’ inside hollow concrete structures.

Figure 13: A thermal labyrinth (left) and a rockbin (right)

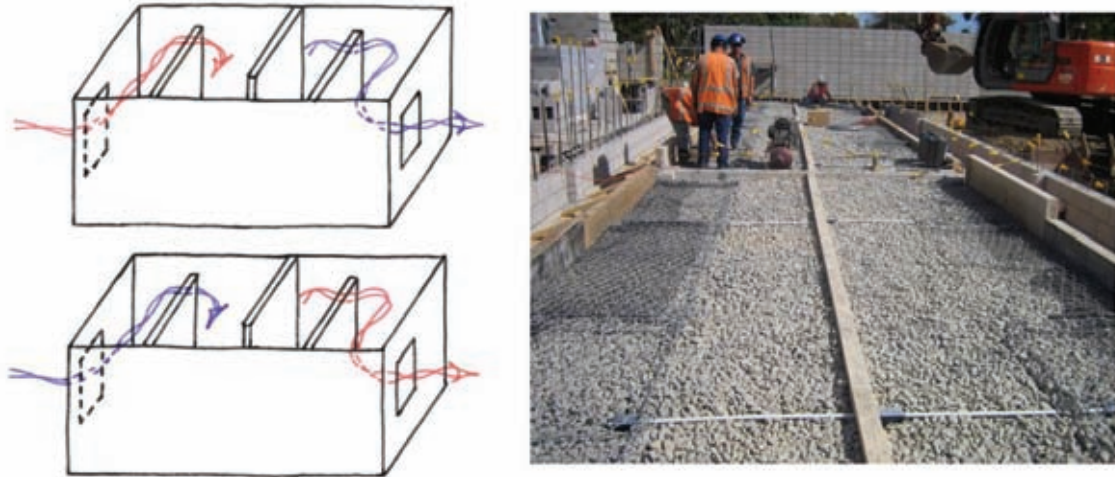

Note: The thermal mass of the labyrinth or rockbin maintains a constant, moderate temperature throughout the year. During summer (top left) the labyrinth removes heat from the incoming air for release during winter (bottom left) when it is used to preheat incoming air. The image on the right is the rockbin under the New Dowse Art Museum – river gravel is caged and buried beneath the structural slab. Incoming air for the building has its temperature moderated as it is drawn through the porous rock.

Unlike the thermal mass used in the building envelope that is designed to control heat variations over a day, a thermal labyrinth or rockbin attempts to moderate temperatures over an entire year. Surplus heat is removed from air coming into the building during summer and is retained until the winter, when it is used to warm the cooler incoming air. As a result, rockbins require very large amounts of mass to maintain a stable temperature over the full year. This, along with the space requirement, makes them particularly expensive unless ‘waste mass’ can be sourced such as old kerbstones or waste rock diverted from landfill. A cheaper alternative is to use the concrete structure of the building as the air-delivery system, ducting the air through hollow concrete beams, or within hollow-core or sine-wave slabs. Ground source heating is a similar option, where pipes are laid horizontally below the surface and used to draw air along them and into the building.

3.4.2 Thermal mass and insulation checklist

- Determine likely gains and therefore predominant load (ie, heating or cooling).
- Arrange mass and insulation to best suit the findings from above.
- Select glazing in coordination with the shading and daylighting strategies.
- Refine to the final solution, taking account of natural ventilation.
- Test using computer simulation throughout the design process.

3.5 Natural ventilation

Studies have linked increased fresh air rates with increased occupant health (Fanger, 2006). Current sustainable building practice is to supply work areas with above-code levels of fresh air. Typical levels are 150 or 200 per cent of the minimum Building Code requirement. Note the Code requirements will vary depending on the type of building. In a mechanical system, the increased fresh air rates carry an energy penalty, as a larger volume of air needs to be heated or cooled to suit the building. A natural ventilation strategy supplies fully fresh air with no conditioning system. This approach provides the benefits of high fresh air volumes with a reduced energy use for heating and cooling systems and mechanical ventilation.

It is important to distinguish between naturally ventilated buildings, in which fresh air is supplied through unforced means, and a building that simply has no cooling or heating capacity in the mechanical ventilation system. Similarly, buildings using an economiser cycle, where the HVAC system brings full fresh air into the building to reduce cooling energy, are not naturally ventilated buildings in the true sense, though an economiser cycle is an effective energy-saving feature.

Natural ventilation strategies make use of two generators of air movement: the stack (or buoyancy) effect where heated air rises, and wind which generates air movement through pressure differences across or within a building. How effectively the stack effect will ventilate a building depends on the gains within the building. Some rooms (eg, school computer suites) will have relatively high gains and air will be heated by equipment, occupants and solar gains. The heated air will then want to rise through the building. The natural ventilation design should take advantage of this fact, release the heated air from the building at high level and then draw fresh air into the building through the facade. For building types that have lower gains (for example, hangars and maintenance sheds) the stack effect may not be the most suitable and they would be better served by wind-driven ventilation. A detailed understanding of the opportunities for using wind-driven ventilation should come from the site analysis undertaken before the design phase starts. The building then needs to be designed to maximise the potential of that site.

Predicting exactly how air will move through a building is extremely difficult. Openings and airflows need to be sufficient to provide the required level of ventilation, cooling and fresh air. Larger buildings may lend themselves to some basic computational fluid dynamic (CFD) analysis as part of the building simulation process; however most projects will have to rely on engineering guidelines and experience.

A naturally ventilated building can never be cooler than the ambient air temperature. As a result, buildings in some parts of the country may still require cooling during warmer months, depending on the building type and its use. Comfort during hot times can be improved using ceiling fans to generate air movement. If supplemental heating systems are required, it can be best to use radiant systems whose heat is felt by the occupants rather than using large amounts of energy directly heating a high proportion of fresh air.

There are several obstacles to using natural ventilation; acoustic requirements may preclude the use of opening windows or other ventilation openings, and Building Code requirements for smoke extraction (particularly in atriums) often require the use of large mechanical fans. Acoustic concerns need to be addressed during site planning, although can be overcome by landscaping features. Vents also need to be weather- and vermin-proof and secure.

3.5.1 Design strategies

Building form

The most suitable shape and layout for naturally ventilated buildings is very similar to that discussed for daylighting. In a building with good crossflow, a natural ventilation strategy will only be effective up to a maximum distance of around 15 metres over an open-plan layout. Hence a long, narrow floor plate is the preferred building form.

One-sided ventilation is only effective for less than half this distance, but is still a good strategy for venting cellular offices or enclosed spaces along one side of the building.

Figure 14: Ventilation guidelines for room dimensions

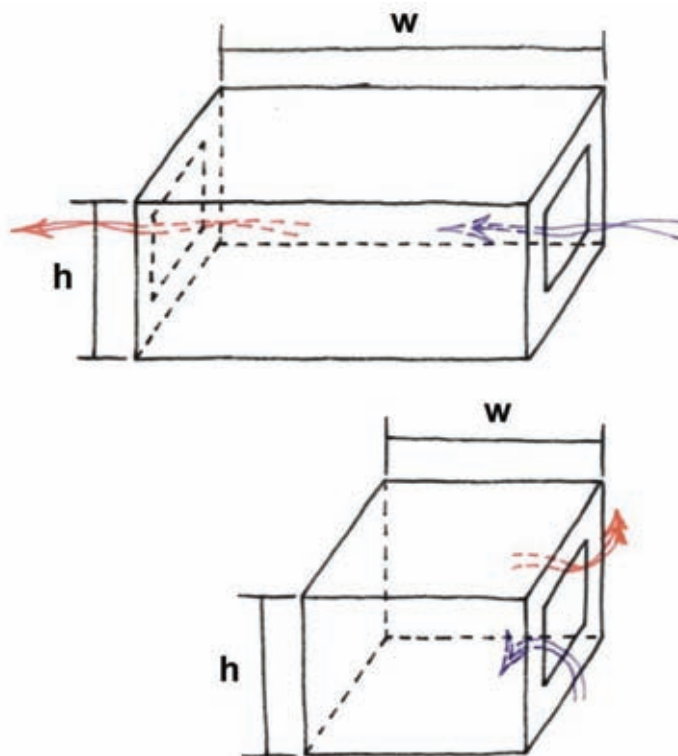

Note: For two-sided ventilation (top) the room width (w) should be around five times the room height (h). For one-sided venting, w should be around $2\frac{1}{2}$ times h . As a guide, the ventilation area should be between 5–10 per cent of the room's floor area.

Care should be taken, however, to ensure the form of the building also suits the site and surroundings.

Windows and vents

The easiest method of bringing outdoor air into a room is to open a window. This is most suitable for cellular offices or classrooms where the occupants are more likely to take 'ownership' of the space and use the window effectively. Adjustable louvres and small, thin 'trickle' vents can be used to provide ventilation when a window cannot, for example during high winds or rain. Ideally, users should have the choice of more than one option.

Openings can be automated and controlled by the BMS, though this adds to the project cost. The control system should also include rain and wind sensors to ensure vents do not open during bad weather.

Atriums

One of the many functions of an atrium is to provide natural ventilation to areas that are difficult to ventilate from the perimeter. The atrium's height allows a temperature gradient to develop, which then creates air movement through the stack effect. Warm air is released at a high level and outdoor air is brought into the building at the perimeter.

Figure 15: A typical natural ventilation strategy with an internal atrium

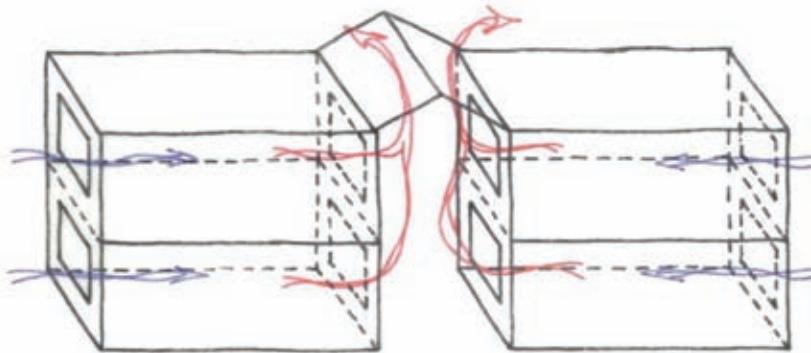

Note: Heated air rising in the atrium draws cool air into the rooms at the perimeter. This allows natural ventilation (and daylight) access to a larger proportion of a building's floor area when its footprint may have been otherwise unsuitable for passive solutions. As a rough rule of thumb, the floor area of the atrium should be around 2 per cent of the area it is used to service.

Lightwells can also be used for natural ventilation if space requirements do not allow the inclusion of a full-sized atrium.

Naturally ventilated atriums may not meet the simple Building Code requirements for smoke extraction. If that is the case, a fire engineer will have to prove compliance through an alternative solution.

Double-skin facades

Over the height of a building, a significant temperature gradient can develop, particularly within the glazed layers of a double-skin facade. The superheated air then rises and is released by vents at the top of the facade. Air is vented from the interior spaces into the facade through automated vents in the inner skin.

Figure 16: Typical natural ventilation strategies within a double-skin facade

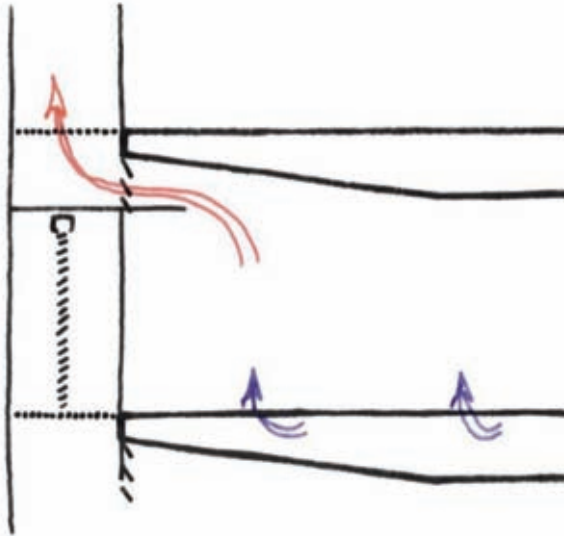

Note: Supply air enters the space (in this case via the floor) and is warmed by internal gains. Stack pressures within the two skins draw extract air at a high level into the double-skin facade which is vented at the top of the building. Airflow in the facade can be significant, and blinds need to be restrained to reduce rattling.

Ventilation and solar chimneys

Similar to a lightwell, though often smaller and enclosed, a ventilation chimney extends above the roofline of a building to vent hot air through the stack effect and/or wind pressure. Internal areas are vented into the chimney. Solar ventilation chimneys include highly glazed areas to increase the temperature gradient within the chimney. Glazed stairwells can also be used for this purpose, as they are effectively a riser that extends throughout the height of the building.

Wind vanes and their control

It is important that design teams consider not only the wind resource at the site, but also the effect the building itself will have on that wind resource, and attempt to use it. The building form can direct air into the space and draw air into the intakes. Using the shape of the building to guide the wind reduces any cost premiums. Additional wind control devices, such as sails or wind vanes that extend into the airflow, can be interesting architectural features, but add to construction costs.

The same considerations apply when using wind generation. Turbines tend to be placed on the roof of the building; however, windflow over the top of a building is often turbulent and low quality. Windflow is often more reliable around the corners of buildings, or in the channelled flow between two neighbouring buildings.

Evaporative cooling

If the site includes a reasonable body of water, or if water features can be incorporated into the design, evaporative cooling may be an option for increasing the cooling potential of a natural ventilation design strategy. The evaporation that occurs at the surface of water extracts heat from the air and, as the temperature of the air falls, its relative humidity rises. Although difficult to apply inside, it can be used if water can be placed at or near the outdoor air source. To optimise evaporative cooling and movement of air and water, extensive water-to-air surface contact is needed. This can be achieved with landscape features, such as ponds, as in the Christchurch Library with its ‘moat’ surrounding the low-level opening windows.

Night purge

This was discussed in greater detail in the section on thermal mass and insulation. If night purging of residual heat is part of the conditioning strategy, the natural ventilation system needs to be designed so that it still performs during cooler night-time temperatures. Vents need to be secure and closed in bad weather.

3.5.2 Natural ventilation checklist

- Use information from the site investigation to determine a suitable ventilation strategy.
- Design building layout and orientation to exploit high- or low-gain areas for ventilation purposes.
- Design the ventilation strategy and align with heating, cooling and shading strategies.
- Refine the strategy throughout the design process, possibly using CFD on larger buildings or for major design features (eg, atriums).
- Mitigate any potential issues with noise intrusion, smoke extraction and so on.
- Ensure the system is commissioned to best practice standards.

3.6 Computer simulation tools

Using computer modelling to predict the daylighting and thermal or energy performance of buildings is becoming increasingly prevalent, particularly with the introduction of Green Star rating tools, where thermal and energy modelling is a conditional requirement.

Modelling can also be used as a compliance method for the energy efficiency and natural light (for domestic situations) clauses of the New Zealand Building Code. While these applications provide a snapshot of a building’s potential, building simulation is best used throughout the design process as a tool to compare and optimise different design strategies (for example, window size, glazing type, arrangement of thermal mass and insulation).

Good passive solar design depends on the complex interaction of several aspects of a building's design. Computer modelling can help designers deal effectively with the complexity of these passive solar design issues, identify and resolve problems of comfort, building performance and energy use, and analyse and fine-tune the design. This accelerates the design process by quickly identifying problems and opportunities, and narrows the range of practical solutions, saving time and money for both the design team and client.

Once a set of workable options is chosen, computer simulation can 'fine tune' the energy-saving strategies and indicate what the comfort levels and energy use of the building are likely to be. The whole building will perform more effectively because the designer will have more information about the interaction between the solar features and the other elements of the building's design.

In a conventional building, computer modelling is normally carried out by the service engineers as part of the mechanical services (HVAC) design, though some projects use specialist environmentally sustainable design (ESD) consultants. In a passive building, where the intent may be to not provide HVAC, modelling would be used to ensure the passive design strategies will perform well enough to meet the building's desired internal conditions.

In a conventional building, designers tend to use simple rules of thumb and experience through the concept and preliminary design stages before incorporating modelling results throughout the developed design stage. On the other hand, a passive building requires feedback from the modelling process to be incorporated as early as possible. It is more likely that passive solar features will be central to the design and form of the building. The modelling tool can also provide useful information on the climate and shading conditions at the site that can then be fed into the preliminary design.

In general, a building simulation package will contain the following information:

- building description – size, shape, orientation, window type, size and orientation, construction material types and their physical properties (eg, thermal conductance, density, and reflectance)
- design data – insulation levels, internal gains from lights, small power and occupants, infiltration and ventilation rates, equipment efficiencies and desired temperature setpoints
- site data – sky information, weather data files (standard files on hourly temperatures, solar radiation and wind information are available from the Department of Energy in the United States (http://apps1.eere.energy.gov/buildings/energyplus/cfm/weather_data.cfm) or within the software itself).

The computer model produces information about the:

- extent of shading and solar access to the site
- climatic conditions using the averaged annual weather data or extreme design conditions
- hourly internal temperatures and comfort conditions
- extent of daylight penetration and likely illuminance levels
- annual, seasonal, monthly, daily or hourly heating and cooling loads
- peak heating and cooling loads
- auxiliary energy consumption.

Care does need to be taken with computer simulation, especially when entering the information into the software, as initial assumptions will need to be made about the building and its design. If those assumptions are inaccurate, this will have a corresponding effect on the modelling results (a phenomenon normally known as ‘garbage in, garbage out’). During a comparative study of two or more scenarios, the effect of any inaccuracies is negated, which is why this method is preferred over a one-off, standalone simulation. When using computer simulation, design teams and modellers should also be conscious of the difference between accuracy (having valid assumptions) and precision (having exact assumptions).

Most experienced engineers will have a good intuitive feel for how a building should perform, and modelling leads to a sense of ‘advanced intuition’. Intuition can be used to check modelling results, while modelling is used to refine intuition and allow quick comparison of building variations. As a result, the design team should have a good working knowledge of the basic concepts of passive solar design. Building simulation is not a substitute for knowledge, but a means of quantifying, refining and calculating the impact of design decisions.

A computer model’s predictions of building performance can be used to establish targets for the building’s energy and water use, and even internal conditions. Care should be taken due to differences in the modelling assumptions from the actual building’s use, or weather conditions experienced by the building compared with the weather data used by the software. Such targets then become important performance indicators through the operation of the building, or within a performance-based lease agreement. Information on performance-based leases is included in the further reading section.

The value of computer simulation for achieving a high-quality building, with potential for significant energy savings, is becoming well established. Properly incorporating simulations into the design process can save the design team time and money, improve client satisfaction, suggest energy opportunities that might otherwise be overlooked, and solve problems that could be difficult and include a cost to change while they are still on the drawing board instead of built into a building.

3.6.1 Building simulation checklist

- Assess the extent of shading and solar access to the site.
- Use computer simulation software and tools to help the site investigation process.
- Model the building fabric at the preliminary stage to determine a baseline level of ‘natural performance’ (eg, the level of comfort and internal illuminance without any artificial systems in the building).
- Compare possible strategies and quantify their effect on comfort and energy use.
- Refine the design during the developed design phase, incorporating any additional lighting or HVAC systems.
- Finalise the model with the design to establish performance targets for future building operation. This model can also be used for Building Code compliance or Green Star submissions, if required.

4 The Benefits

The intention behind incorporating passive solar design features is to reduce, or negate the need for, energy consumption for conditioning and/or lighting in a building. This energy consumption accounts for a significant proportion of a building's energy use. Passive solar design can therefore lead to significant energy cost savings over the life of the building. Passive systems are often simpler and, if commissioned properly, cheaper to maintain. If there is any increase in capital cost, it is likely to be repaid five to six times over a 20-year period by operating cost savings, depending on the building type (Ministry for the Environment, 2005).

Because passive buildings also tend to be more integrated, the building system required can be less sophisticated. As a result, passive solar buildings are often more flexible and durable which ensures a longer life (Cole, 2000).

Buildings with a high degree of natural light and ventilation also tend to be healthier, more pleasant buildings to work in, so users are easier to retain and are less likely to take sick days, meaning a 'hard' productivity benefit. Hard productivity benefits include reduced absenteeism, staff turnover and churn, which are easily quantifiable.

Soft productivity benefits relate to users being more productive because they are happier with their environment. This is much more qualitative, though studies have suggested a link between daylight and natural ventilation in schools and improved student performance (Heschong Mahone, 1999). A more healthy environment is particularly beneficial in hospitals, where the use of natural ventilation instead of recirculated air reduces the spread of airborne infections (Arup, 2008). It has also been suggested that higher levels of natural light improve patient recovery times.

5 The Costs

In many respects, the cost of a passively designed building is the same as a similar high-grade building designed to best practice. Most passive solar design principles do not contribute to the capital cost of a project, but may require additional consideration at the design stage.

An increase in capital costs may arise from the strategies used and building design, and even then their effect can vary widely. While some strategies may be cost-neutral, some may reduce costs while others come at a significant premium. A double-skin facade, for example, essentially adds a second layer of glazing to the costs of a project, but is a very good solution for thermal and visual comfort and natural ventilation. Using the building structure (eg, shell beams, hollow core floor slabs) for air distribution reduces or eliminates the necessity for metal ductwork and can reduce costs. In a fully passive building, there is also no requirement for a mechanical HVAC system, a potentially large saving in capital costs. Shading features used on a passive building would not be included in a conventional design, and the glazing is likely to be a higher specification and carry a cost premium. Electric lighting is required regardless of whether daylighting has been successfully integrated into the design, but would be used less often with energy cost savings. A fully integrated daylight control system would include equipment not required in a standard building.

The investment in passive solar design is made with the expectation that any premium will be repaid through energy savings. Building simulation can be used to predict these energy savings and assess the cost-effectiveness of different design options.

A successful passive building requires a more involved design process, or an integrated whole building design approach. The design team's involvement earlier in the design process means costs are higher at the beginning of the project. A greater level of interaction between team members is required throughout the design process and poor management can increase project costs. However, this approach can prevent problems occurring further on in the design process and thereby reduce costs at later stages of the project. A well-run passive design can save the design team time and therefore money, and eliminate problems before construction has begun.

6 Case Studies

6.1 Mathematics, Statistics and Computer Science Building



The Maths, Statistics and Computer Science Building (MSCS) at the University of Canterbury was designed to include passive heating, cooling and ventilation features to help it achieve the required energy target that was set at the beginning of the project. This was supported by both the architects' and engineers' desire for a passive low-energy building, maximising both natural ventilation and large amounts of daylight. Thermal modelling and computational fluid dynamics were used to assess the comfort levels of spaces in the building. Integrated features of the building perform multiple functions where possible to minimise materials use and recognise the interconnectedness of some of the design principles.

The 11,500m² building consists of two main accommodation blocks either side of a five-storey atrium. The northern block contains staff and postgraduate offices, while the second block (at the rear in the photo above) contains the undergraduate teaching areas. A basement under the atrium contains further teaching and service spaces, with circulation towers enclosing the glass-roofed atrium at each end.

All staff have access to a user manual for the building to ensure the building is used as the design team intended. In a 2001 post-occupancy evaluation, students and staff rated the building highly. It reached a level of satisfaction (measured by noise, lighting, overall comfort, summer and winter temperatures) in the top five percentile of the 2001 benchmark data set. All user control ratings were in the top 15 per cent of the benchmark data set, significantly higher than the benchmark.

6.1.1 Site

The building has its long axis lying north-west to south-east and follows the university grid pattern. The building is in the new Science West Precinct that will also include the Future Sciences Library building. The MSCS building and the Future Sciences Library building share a new, centrally located artesian borehole for cooling. The borehole water is discharged back to and supplements the flow back in the nearby Oakover stream. Offices are placed to maximise views of the Southern Alps. The more densely occupied teaching facility with computers is oriented to the south. The sun is controlled to the east and west by massive shear walls with restricted openings. Thermal mass was used specifically to provide stable and natural temperature control for Canterbury's wide range of temperatures, thanks to the north-west/southerly wind shifts.

6.1.2 Natural ventilation

The 6.8 m wide atrium is used to help natural ventilation through the building. Fresh air is drawn through the accommodation blocks, through a double height space and into the atrium via automated internal windows. The academic offices have a very high level of individual control with a variety of natural ventilation options available to the occupants shown below. The vents, openable windows, louvres and shutters are also effective in controlling internal temperatures with little reliance on external energy. In the post-occupancy review, it was found that overall air quality was rated highly, while noise levels were found to be generally acceptable. This is an excellent result for a naturally ventilated building.

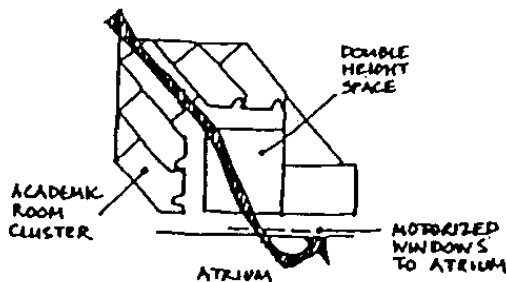

6.1.3 Passive heating and cooling

Temperatures are controlled using thermally massive materials, predominantly exposed concrete. The offices have exposed concrete walls and the teaching areas exposed structural floor slabs. The floor slabs are sinusoidal in shape with the voids being used as air supply ducts (and for cable reticulation) while also providing a large, column-free floor plate. This use of the slab's thermal mass helps maintain an even internal temperature.

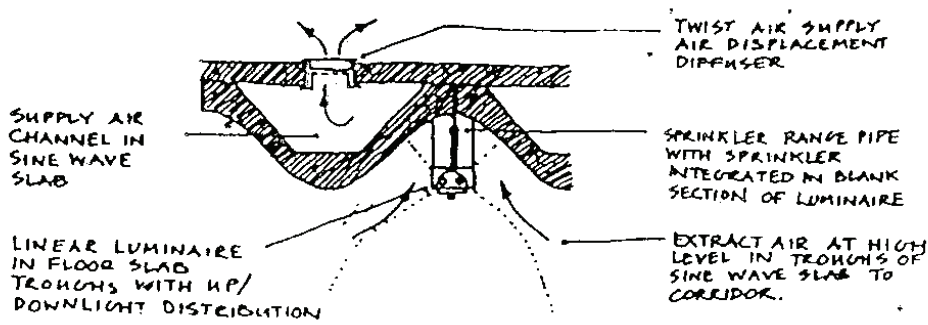

The passive features were supplemented with active systems where required, particularly areas of high internal gains, such as the teaching levels and computer suites. Aquifer ground water was used for heat rejection from the main chillers for improved energy efficiency.

Summer and winter temperatures were rated as comfortable by both staff and students (ie, both permanent and transient occupants) during the post-occupancy review.

6.1.4 Daylighting

The main daylighting feature is again the central atrium. Its sloping glazed roof is oriented to the south-west to give high daylight penetration, rather than sunlight, while its internal walls to the adjoining wings are fully glazed. The intermediate spaces between the atrium and the rear of the offices are double height to maximise the amount of daylight reaching the occupied areas of the building.

As the offices are on the northern facade of the building, they require a well-thought-out shading strategy to allow good daylighting while reducing any possible glare effects. The office's facade design incorporates several movable shades and adjustable louvres so the occupants can alter the level of light to suit their needs.

The supplementary electric lighting system has been designed to be highly efficient with an electricity consumption of 9 W/m² (half the New Zealand standard at the time). Occupants rated lighting, both natural and artificial, highly in the post-occupancy review.

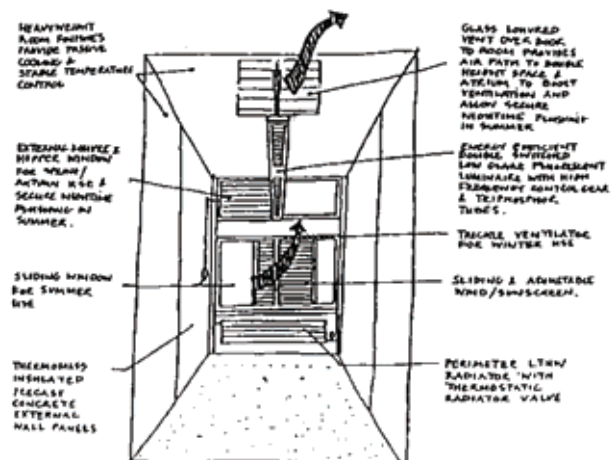

6.1.5 Economics

The cost of the project was calculated as being \$2,000/m² which is 15 per cent below the estimated conventional cost of \$2,300/m² (Ministry for the Environment, 2007). An energy audit showed the annual energy consumption to be 140kWh/m² which is below the standard annual energy consumption for a building of this size at 185kWh/m² (Ministry for the Environment, 2007).

In 2001, a post-occupancy evaluation was carried out on the building to give occupants feedback on its performance and to compare the ratings with UK national benchmarks. The UK benchmark for perceived productivity for 2001 was minus 1.87 per cent. The productivity score at MSCS was plus 9.80 per cent (percentile 97 per cent). This should be read to mean 'occupants think that the building boosts their productivity at work by about 10 per cent, compared with their experience of other working environments'.

6.1.6 Credits

Client: University of Canterbury

Project manager: University of Canterbury

Architects: Architectus CHS Royal Associates

Quantity surveyors: Shipston Davies

Contractor: Naylor Love

Mechanical, electrical and fire engineers: Ove Arup and Partners New Zealand Ltd



6.2 Waitakere Hospital



The Waitemata District Health Board and Waitakere City Council worked in partnership with the community to ensure their new hospital fitted within Waitakere City's Eco City vision. As part of the project development, a series of environmental design principles were created which underpinned the design direction. These included energy efficiency, maximising the use of natural lighting and, being a hospital, additional environmentally friendly strategies which included avoiding waste, safe disposal of hazardous goods and various water-saving and treatment features.

The 14,700 m² building houses 82 beds over five wards and includes operating theatres, a radiology and imaging department, emergency department and acute assessment unit, plus the hospital's support services such as kitchens and cafeteria.

6.2.1 Site

The hospital is located in a residential area of central Waitakere on a site large enough to contain car parking, and stormwater retention ponds that provide a public amenity for the site. The site has excellent solar access, as there is no overshadowing from surrounding buildings. Similarly, the openness allows a reasonable breeze for natural ventilation, the only obstacle being the building itself.

The site development included partial refurbishment of existing buildings and the construction of new facilities. Swales and rain gardens are used to deal with run-off from car parks. Public access has been improved and made easier with a barrier-free philosophy.



6.2.3 Natural ventilation

The orientation of the building was adjusted to improve natural ventilation and to reduce the risk of overheating. Courtyards were created in the middle of the new buildings to bring sun, light and air into the interior and provide green space for the occupants.

Natural ventilation was used as much as possible. This meant splitting the building into air-conditioned zones, such as operating theatres, and naturally ventilated zones, such as older wards and public areas. The intention was to create healthy and low-energy environments closely in tune with the outdoor environment.

The supplemental air supply systems made use of the partial recirculation of air using an economiser cycle. This improves the efficiency of the system by using outside air for cooling when conditions permit. This approach reduces operating costs for the building.

6.2.3 Passive heating and cooling

The design is relatively lightweight and relies on insulation rather than thermal mass to maintain comfortable temperatures. The levels of insulation were increased from Building Code levels, with R 2.0 insulation in the walls and R 3.5 in the ceiling. Fibreglass was used in encapsulated locations and polyester in exposed locations.

Solar shading and special glass was specified on the northern windows of the wards to avoid overheating. It is unreasonable to expect that passive design features will adequately condition all areas of the building due to the highly serviced nature of the building type. Waitakere Hospital makes the best use of passive systems where they are most suitable.

6.2.4 Daylighting

The use of natural light and a connection to the outdoors was integral to the design as, anecdotally, they are beneficial to a patient's recovery. The courtyard design brings daylight into the building, while deeper-than-usual windows still allow bed-bound patients a direct view outdoors. Because patients have restricted movement, shading is used to reduce glare effects from direct sun. Double-height ceilings are used in transient areas to allow high daylight penetration and reduce reliance on artificial lighting.



Where artificial lighting is required, energy consumption is further reduced using daylight dimming, localised switching, and high-efficiency fittings and ballasts.

6.2.5 Economics

Energy modelling and lifecycle costing on systems and construction was used to identify real opportunities for cost-effective design. Adding sustainable building strategies was initially seen as too expensive, but a subsequent feasibility study and loan funded by the Energy Efficiency and Conservation Authority (EECA) under its design energy audit and Crown loan scheme proved otherwise. For example, the natural ventilation strategy had an initial cost premium of \$50,000 and a simple payback of 0.33 years. A grant was also received from Infrastructure Auckland for the stormwater measures included in the project. The overall premium was estimated to be 1.5 per cent above the conventional cost.

6.2.6 Credits

Client: Waitemata District Health Board

Project manager: Carson Group

Architects: Di Carlo Potts Architects (Sydney)

Quantity surveyors: Rider Hunt

Services engineers and energy consultant: Connell Mott MacDonald

Civil engineer: Harrison Grierson

Structural engineer: Buller George

Sustainable design consultant: Robert Vale, Waitakere City Council Sustainable Design Advisor

7 References

- Allen T, Bell A, et al. 2004. *Working Without Walls: An insight into the transforming government workplace*. London: Office of Government Commerce.
- Arizona Solar Centre. *Passive Solar Heating and Cooling: Passive Solar Architecture – Heating*.
- Arup Ltd. 2008. *Future Shape of Sustainable Design for World's Hospitals*, Arup. From <http://www.arup.com/arup/feature.cfm?pageid=6197> accessed 17/12/08.
- Cole R. 2000. *Cost and Value in Building Green*, *Building Research and Information Journal*, 28.5–6 p304–309.
- Commission for Architecture and the Built Environment and the British Council for Offices. 2005. *The Impact of Office Design on Building Performance*.
- Energy Efficiency and Conservation Authority, 2000. *The Dynamics of Energy Efficiency Trends in New Zealand*. Energy Efficiency and Conservation Authority, New Zealand.
- Fanger PO. 2006. *What is IAQ?* *Indoor Air* 2006; 16:328–334
- Hastings SR. 1994. *Passive Solar Commercial and Institutional Buildings: A Sourcebook of Examples and Design Insights*. International Energy Agency. France. John Wiley and Sons.
- Haynes B, Matzdorf F, et al. 2000. *Does Property Benefit Occupiers? An evaluation of the literature*. Facilities Management Graduate Centre, Sheffield Hallam University.
- Heschong Mahone Group. 1999. *Daylighting in Schools: An Investigation Into the Relationship Between Daylighting and Human Performance*. California, United States of America.
- International Energy Agency. 1988. *Task 8 – Passive and Hybrid Solar Low Energy Buildings: Design Information Booklet Four*.
- International Energy Agency. 2001. *Task 21 – Daylight in Buildings: Application Guide for Daylight Responsive Lighting Control*.
- Leaman A, Bordass B. 2001. *Assessing building performance in use 4: the Probe occupant surveys and their implications*. *Building Research and Information* 29(2): 129–43.
- Levine M, Ürge-Vorsatz D, Blok K, Geng L, Harvey D, Lang S, Levermore G, Mongameli Mehlwana A, Mirasgedis S, Novikova A, Rilling J, Yoshino H. 2007. *Residential and Commercial Buildings*.
- Ministry for the Environment. 2005. *The Value Case for Sustainable Building in New Zealand*. Ministry for the Environment, New Zealand.
- O'Connor J, Lee E, Rubinstein F, Selkowitz S. 1997. *Tips for Daylighting with Windows*.
- Property Council of Australia. 2003. *Sustainable Development Guide: A road map for the commercial property industry*. Property Council of Australia, Sydney, Australia.
- United States Department of Energy. 2000. *Passive Solar Design*.

8 Further Reading

8.1 Passive design of houses

DBH. Smarterhomes website: www.smarterhomes.org.nz

BRANZ. Level website: www.level.org.nz

EECA. Designing for the Sun: www.eeca.govt.nz

EECA/CCANZ. Designing Comfortable Homes: www.eeca.govt.nz and www.cca.org.nz

CCANZ. Building Comfortable Homes: www.cca.org.nz

8.2 Integrated whole building design

Ministry for the Environment. *Integrated Whole Building Design Guidelines*: www.mfe.govt.nz

8.3 Commissioning

Ministry for the Environment. *Sustainable Government Buildings: Beyond Design – A Best Practice Approach to Building Commissioning, Completing and Ongoing Operation*: www.mfe.govt.nz

8.4 Value cases

Ministry for the Environment. *Value Case for Sustainable Building in New Zealand*: www.mfe.govt.nz

8.5 Sustainable building cases

Ministry for the Environment. *Sustainable Building Case Study: Conservation House Whare Kaupapa Atawhai*: www.mfe.govt.nz

8.6 Outline building briefs

Ministry for the Environment. *Meridian outline building brief*: www.mfe.govt.nz

8.7 Fit-outs

Ministry for the Environment. *A Guide to Sustainable Office Fit-Outs*: www.mfe.govt.nz